

Kitchen



Client: Russell Lilley Construction
Project Name: George Street Unit 1
Site Address: 30 George Street, Rolleston

Designer: Beck
Date: 23 May 23
Page: 1 of 4

Please note that all dimensions provided are subject to verification on job site and adjustment to fit job conditions. 3D renders are an artistic interpretation of the general appearance of the design, they are not an exact rendition therefore colours etc may vary. This design must not be released or copied until after job order has been placed

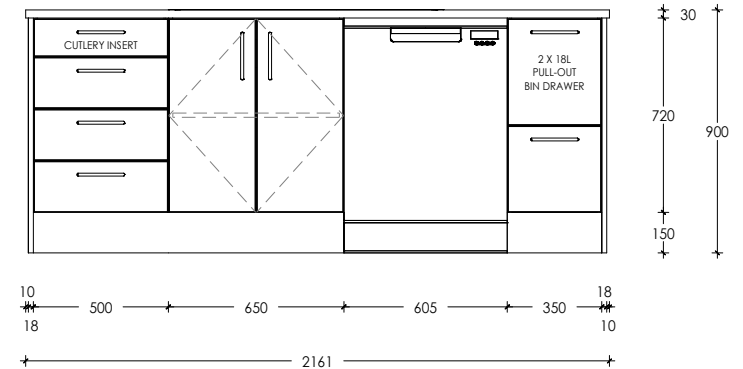
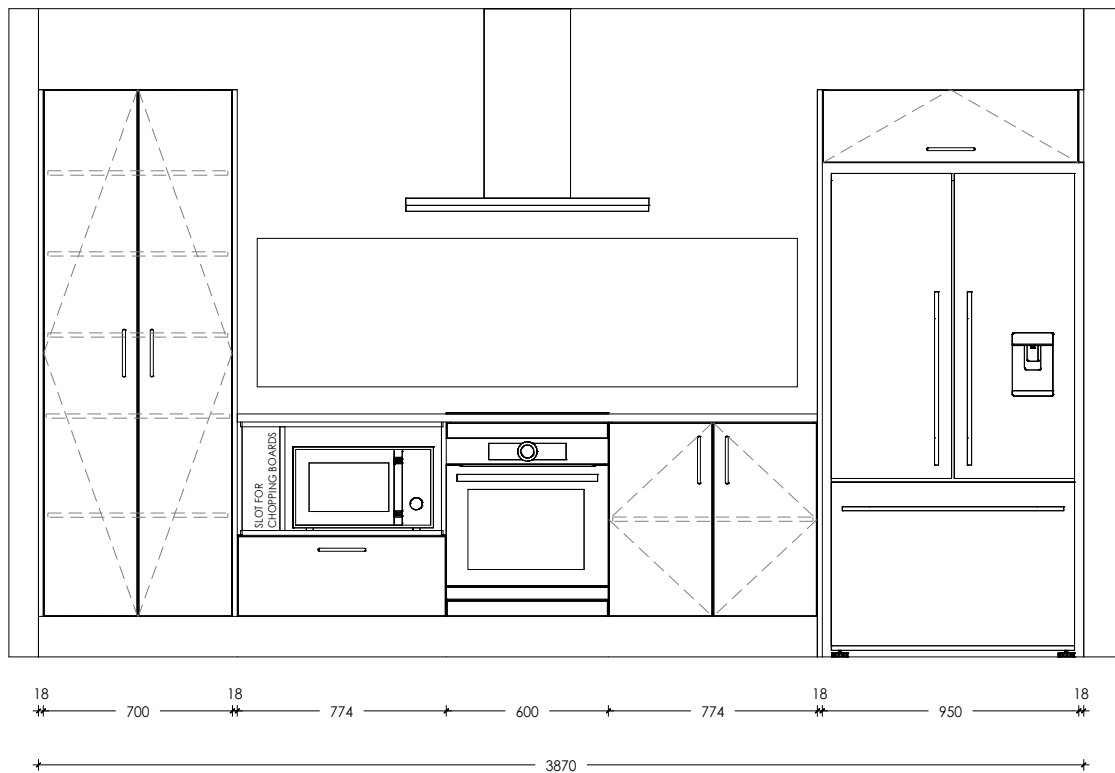

Kitchen



Client: Russell Lilley Construction
Project Name: George Street Unit 1
Site Address: 30 George Street, Rolleston

Designer: Beck
Date: 23 May 23
Page: 2 of 4

Please note that all dimensions provided are subject to verification on job site and adjustment to fit job conditions. 3D renders are an artistic interpretation of the general appearance of the design, they are not an exact rendition therefore colours etc may vary. This design must not be released or copied until after job order has been placed

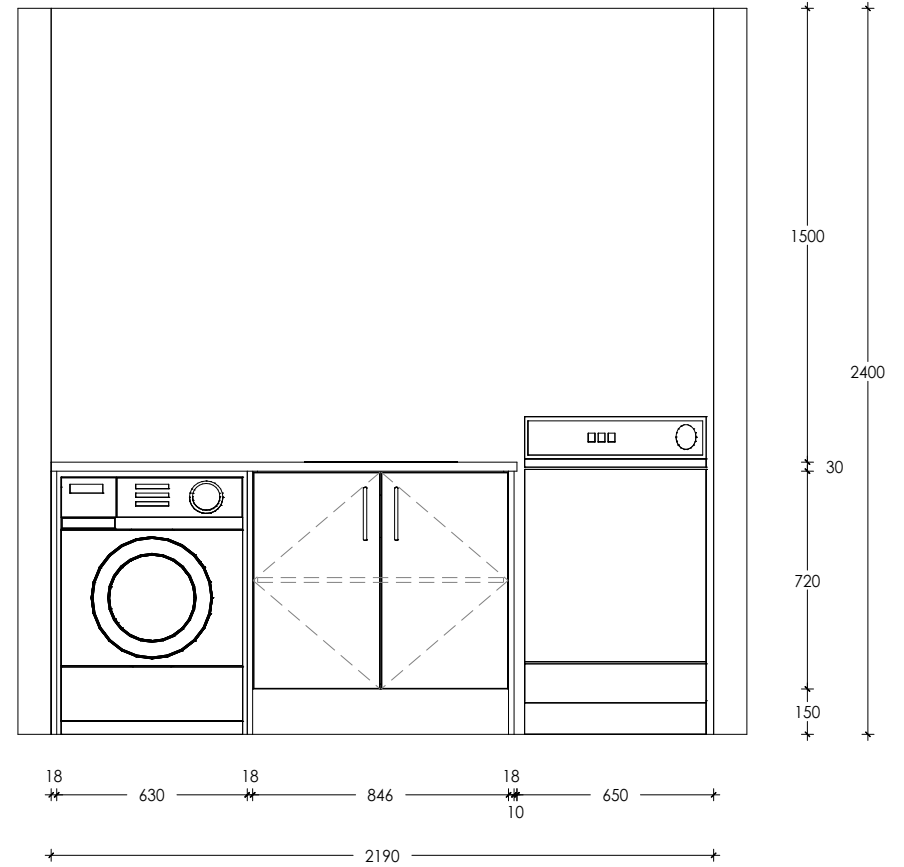
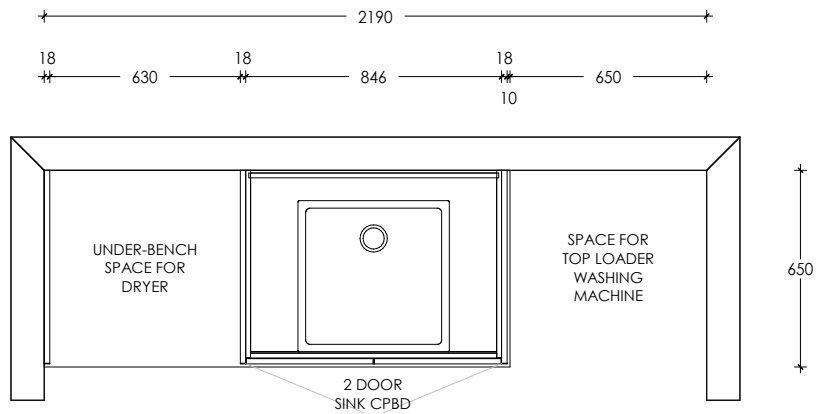

Laundry



Client: Russell Lilley Construction

Project Name: George Street Unit 1

Site Address: 30 George Street, Rolleston

Designer: Beck

Date: 23 May 23

Page: 3 of 4

Please note that all dimensions provided are subject to verification on job site and adjustment to fit job conditions. 3D renders are an artistic interpretation of the general appearance of the design, they are not an exact rendition therefore colours etc may vary. This design must not be released or copied until after job order has been placed

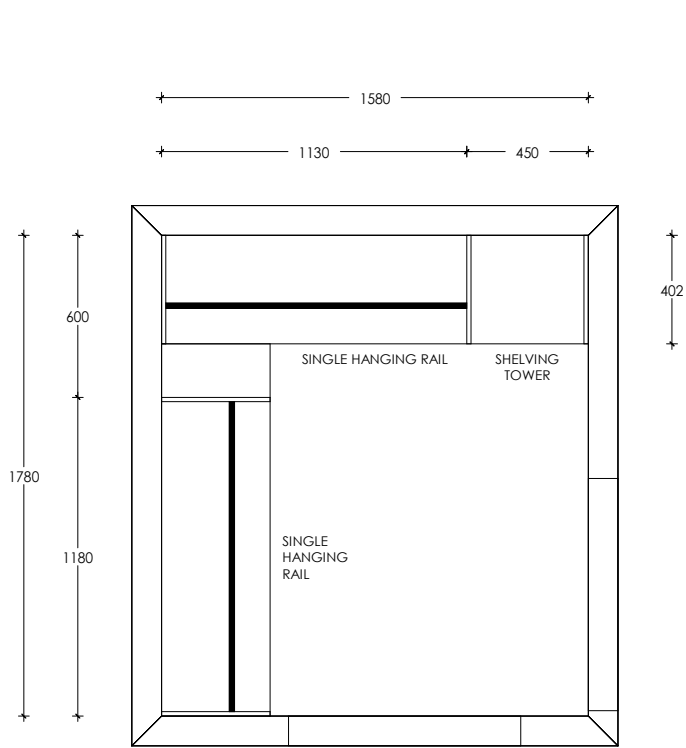

Master Walk-In Robe

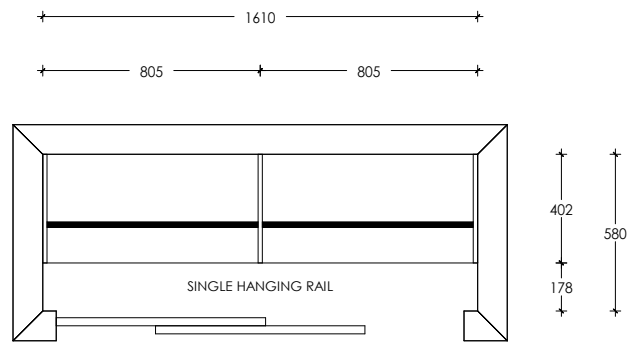

Bedroom 2 Robe

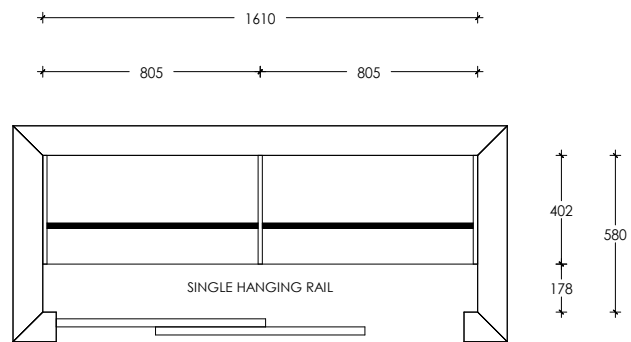

Bedroom 3 Robe

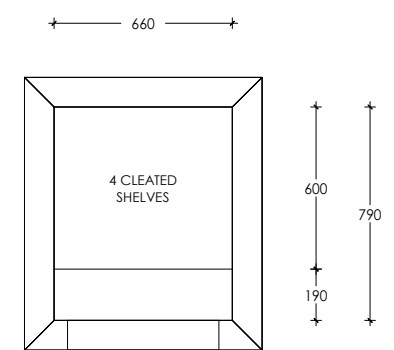

Storage

Robes / Storage



Client: Russell Lilley Construction
Project Name: George Street Unit 1
Site Address: 30 George Street, Rolleston

Designer: Beck
Date: 23 May 23
Page: 4 of 4

Please note that all dimensions provided are subject to verification on job site and adjustment to fit job conditions. 3D renders are an artistic interpretation of the general appearance of the design, they are not an exact rendition therefore colours etc may vary. This design must not be released or copied until after job order has been placed